

Accessory List		
Parts name	Remarks	Qty
Earth Bolt M8 × 12	For Earth terminal	2
Key (Key No. N200)	For Handle	1

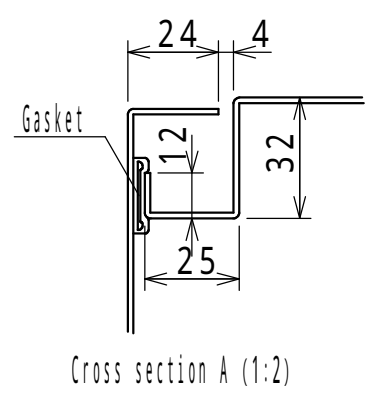

NOTE
 1. The door opening angle is approximately 103°.
 2. The usable depth of both doors fitting section is 43 mm deeper than the usable depth in drawing.

Enclosure specification		Model	RA 12 - 33						
Type	Indoor / outdoor use, RA12-33	DRAWING A3 scale	1/2						
Body	Steel t 1.6								
Door	Steel t 1.6								
Mounting plate	Steel t 2.3	Scale	1:5	Design	ITOU	Draw	NGUYEN	Check	SUZUKI
Color	Standard / Light beige (5Y7/1)	Date:	25 / Mar. / 2021						
IP	IP54 (Category 2)								
Weight	5.7 kg								

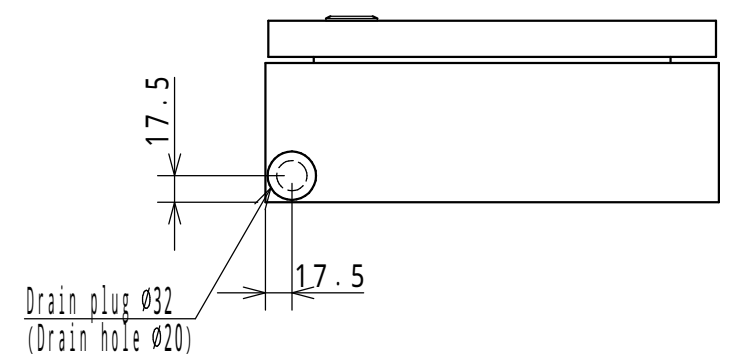
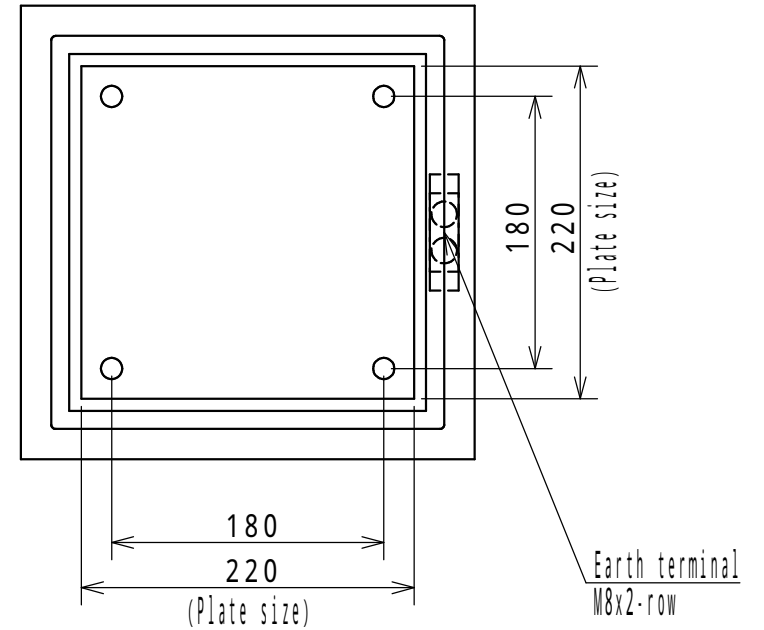
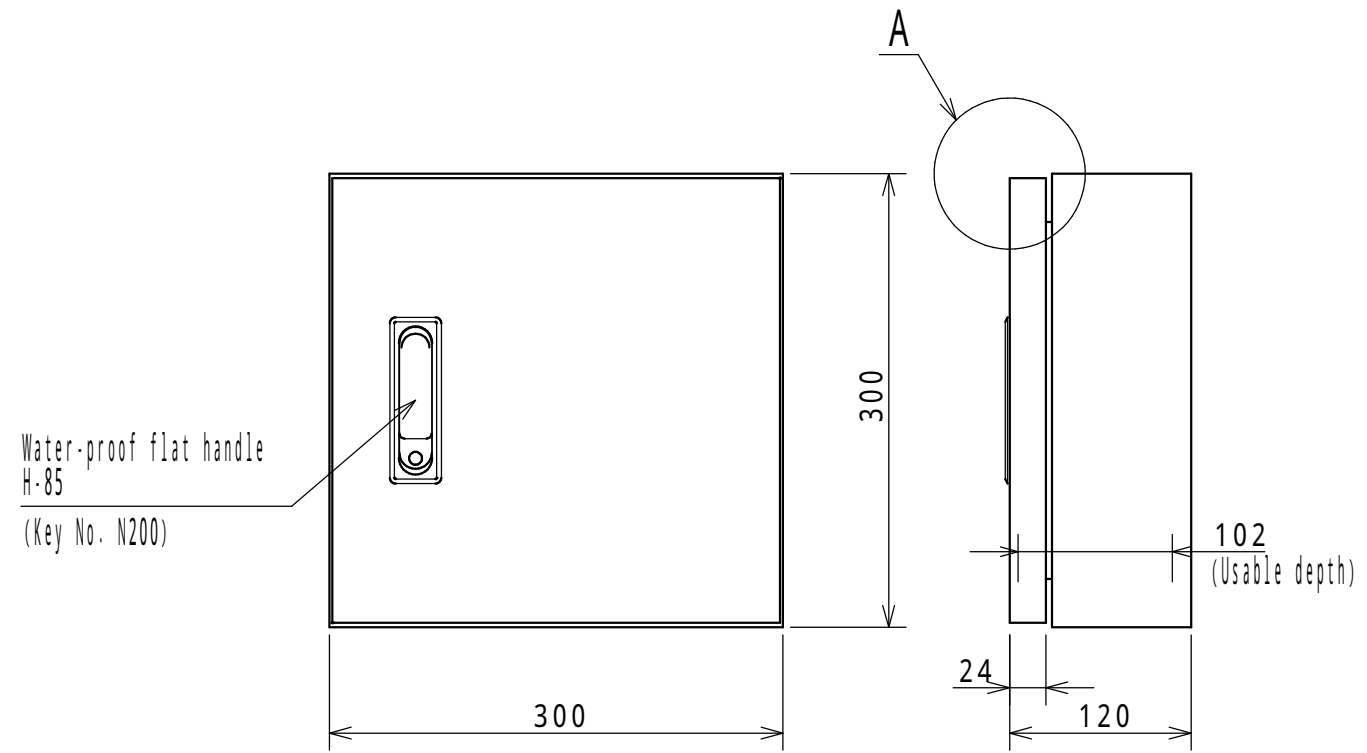
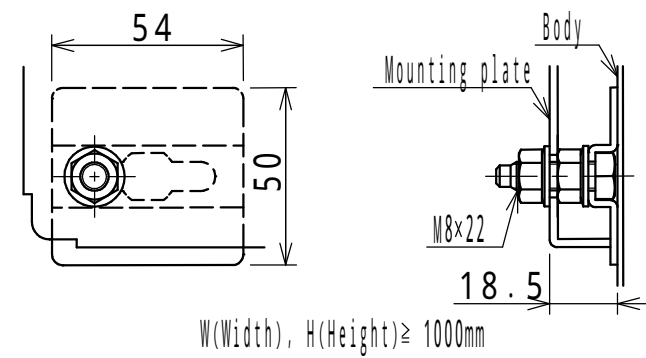
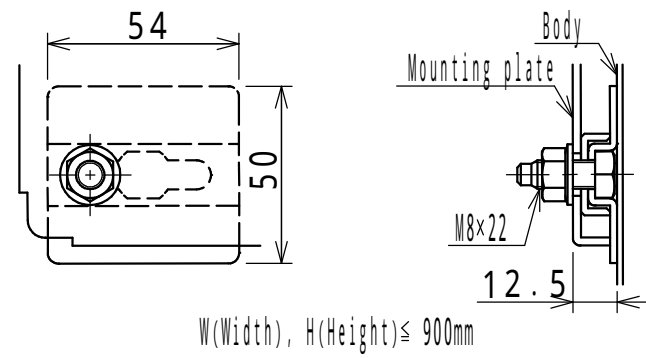

Detail B: Mounting plate installation (1:2)

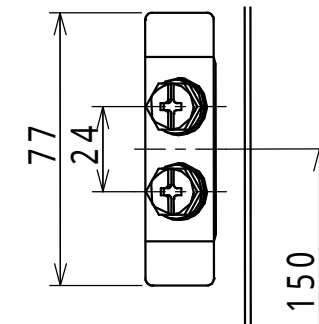

Detail C: Earth terminal(1:2)

Model	Detail view RA				
Number					2/2
A3 scale	Scale	Design	ITOU	Draw	NGUYEN
					Check
					SUZUKI
Date:		25 / Mar. / 2021			