

Accessory List		
Parts name	Remarks	Qty
Earth Bolt M8 × 12	For Earth terminal	2
Key (Key No. N200)	For Handle	1

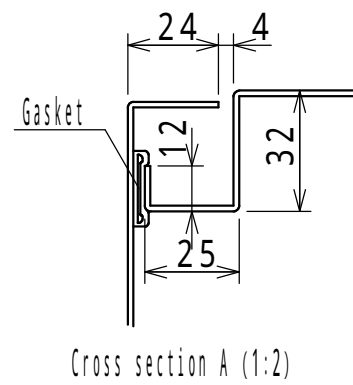
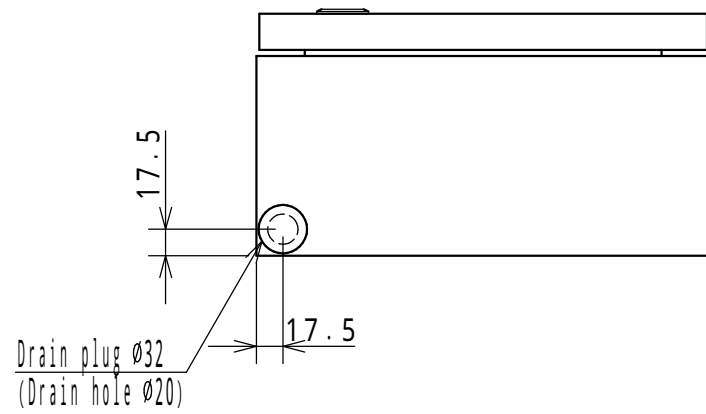
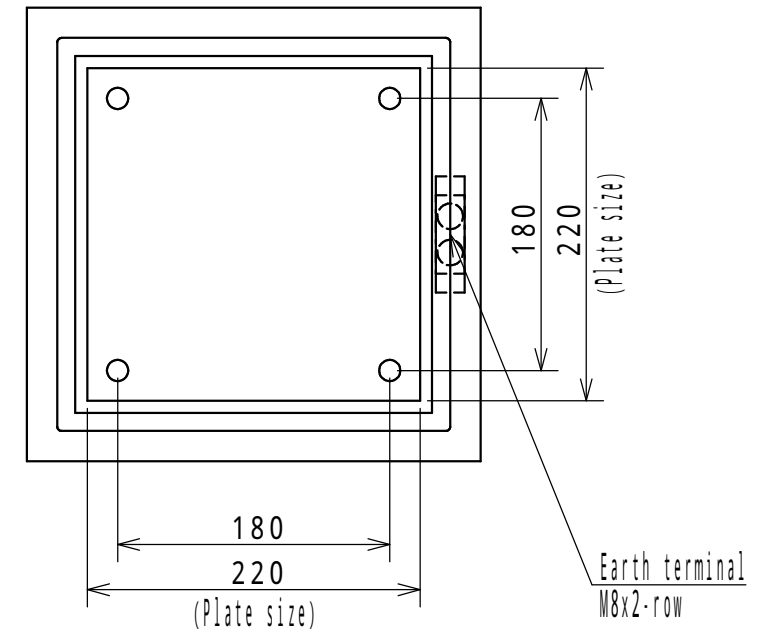
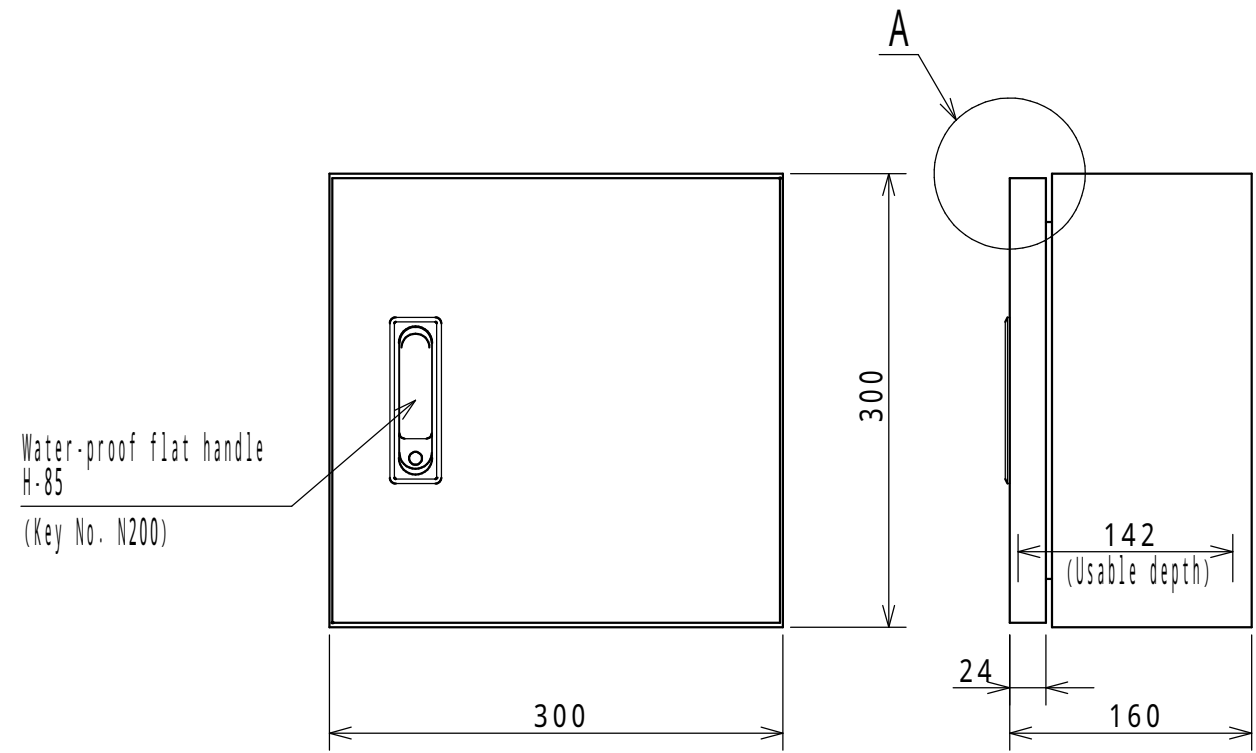

NOTE

1. The door opening angle is approximately 103°.
2. The usable depth of both doors fitting section is 43 mm deeper than the usable depth in drawing.

Enclosure specification		Model	RA 16 - 33							
Type	Indoor / outdoor use, RA16-33	DRAWING A3 scale	1/2							
Body	Steel t 1.6									
Door	Steel t 1.6									
Mounting plate	Steel t 2.3	Scale	1:5	Design	ITOU	Draw	NGUYEN	Check	SUZUKI	
Color	Standard / Light beige (5Y7/1)	Date:	25 / Mar. / 2021							
IP	IP54 (Category 2)									
Weight	6.2 kg									

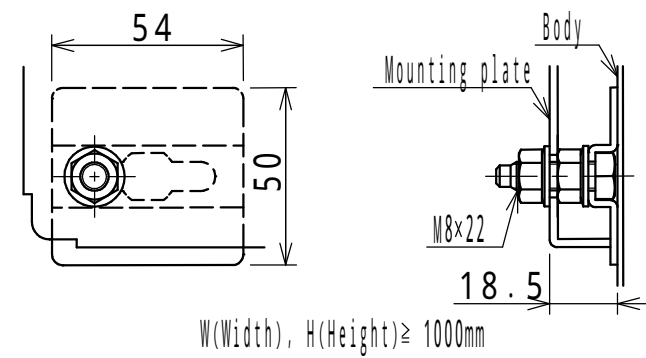
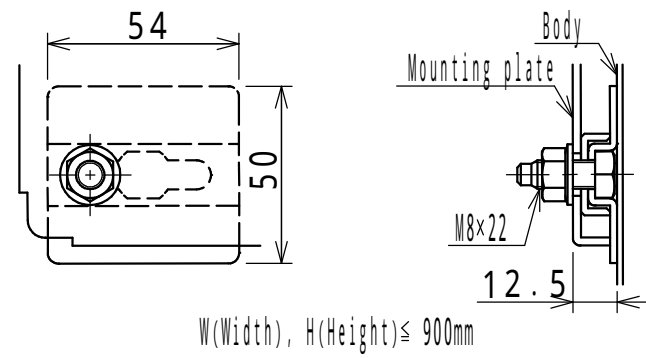

Detail B: Mounting plate installation (1:2)

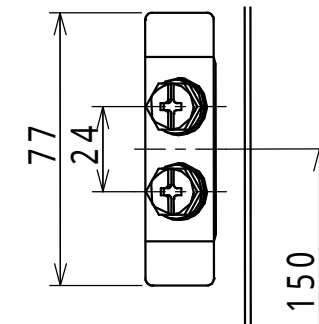

Detail C: Earth terminal(1:2)

Model	Detail view RA				
Number					2/2
A3 scale	Scale	Design	ITOU	Draw	NGUYEN
					Check
					SUZUKI
Date: 25 / Mar. / 2021					