

Model	Wall-mounting, indoor/outdoor-use, CA16-43			Name/Type	CA16-43			
Body	Steel sheet, t1.2							
Door	Steel sheet, t1.2			Drawing number	-			
Mounting plate	Steel sheet, t1.5							
Base	-			A3 scale	Scale	Design	Drawing	Check
Color	Outside	Light beige (5Y7/1) (Smooth)						
	Inside	Light beige (5Y7/1) (Smooth)						
IP	IP65			Date	1:5	SUPAKIT	SUPAKIT	KONISHI
Weight	6.4 kg							
					21 / Sep. / 2021			

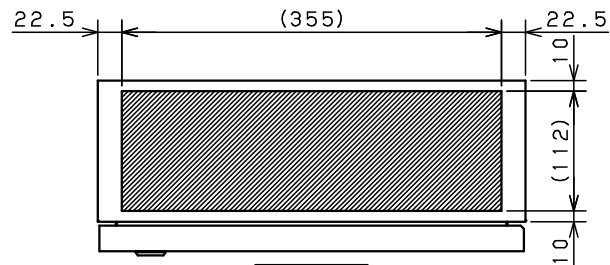

Top

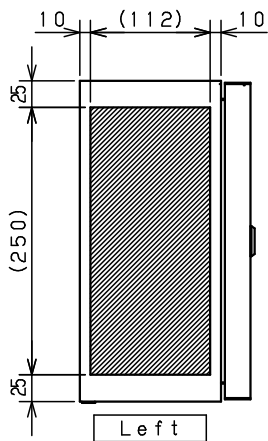
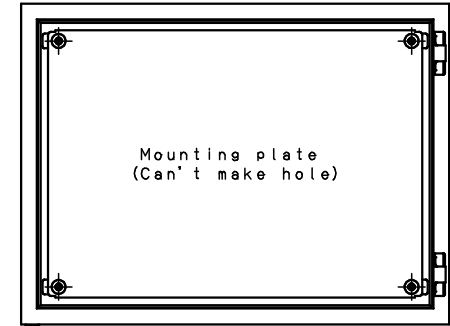

Left

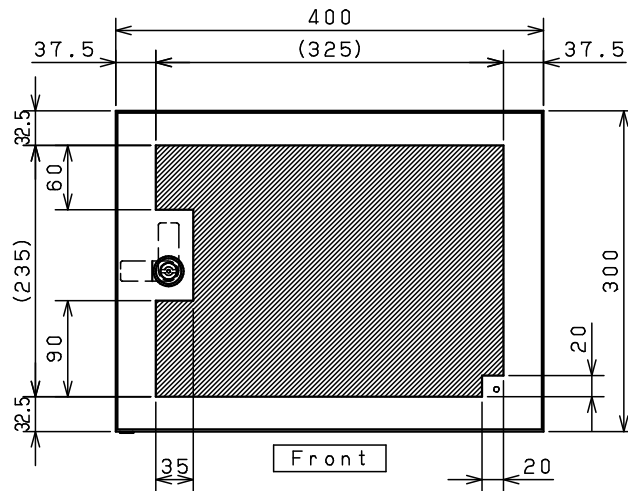

Front

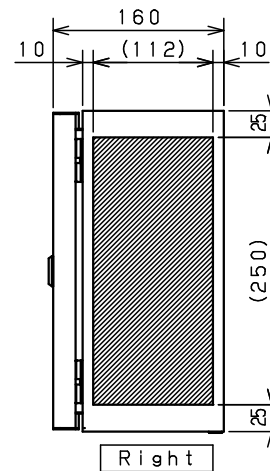

Right

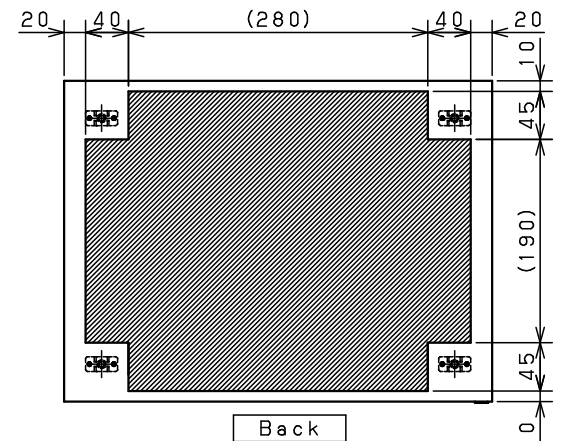

Back

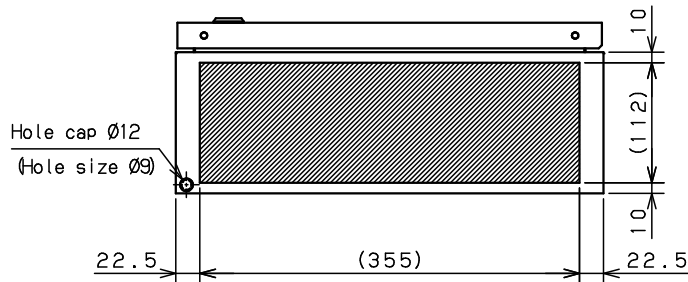

Bottom

Note2. This drawing shows the processing range by laser.  
 Note1. Please refer to standard drawings for cabinet details.

Model	Wall-mounting, indoor/outdoor-use, CA16-43	Name/Type	CA16-43/LSR			
Body	Steel sheet, t1.2	Drawing number	-			
Door	Steel sheet, t1.2					
Mounting plate	Steel sheet, t1.5	A3 scale	Scale	Design	Drawing	Check
Base	-		1:5	SUPAKIT	SAICHON	TSUGE
Color	Outside Light beige (5Y7/1) (Smooth) Inside Light beige (5Y7/1) (Smooth)	Weight	Date 6 / Oct. / 2023 A			
IP	IP65					

2/2