

Model	Wall-mounting, indoor/outdoor-use, CA20-45			Name/Type	CA20-45			
Body	Steel sheet, t1.2							
Door	Steel sheet, t1.2			Drawing number	-			
Mounting plate	Steel sheet, t1.5							
Base	-			A3 scale	Scale	Design	Drawing	Check
Color	Outside	Light beige (5Y7/1) (Smooth)			1:10	SUPAKIT	SUPAKIT	KONISHI
IP	IP65			Date	21 / Sep. / 2021			
Weight	10.3 kg							

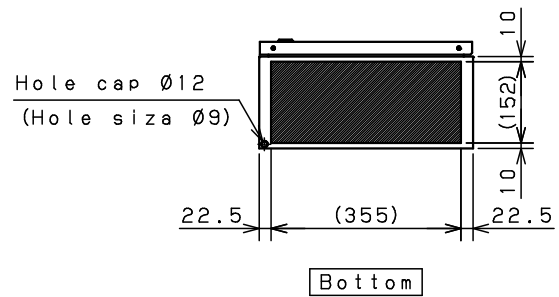
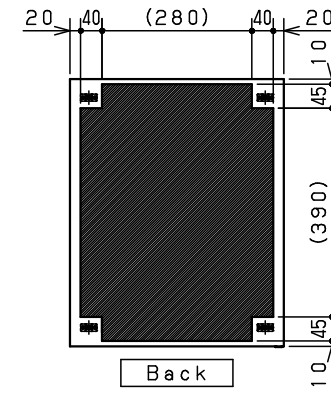
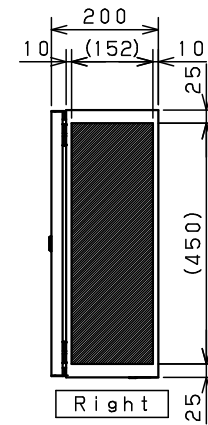
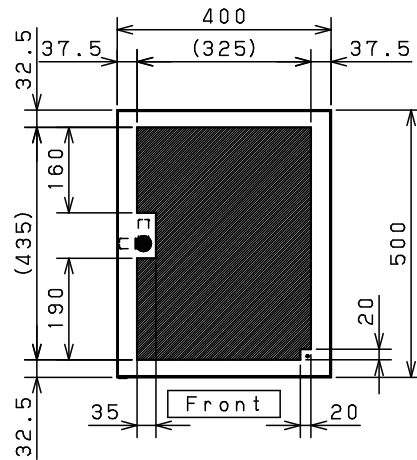
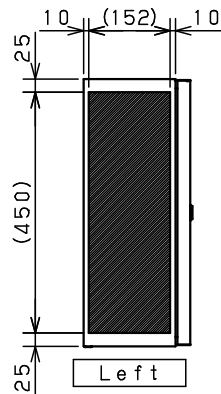
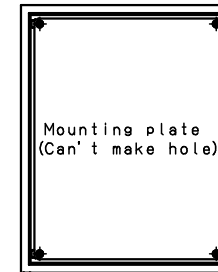
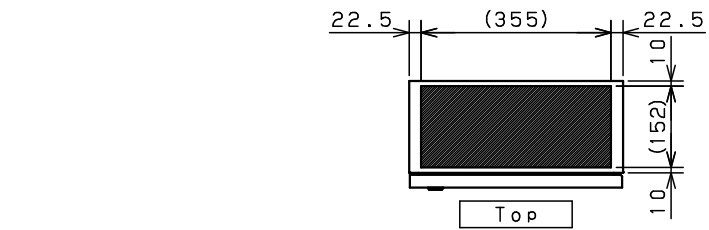

Note2. This drawing shows the processing range by laser.
 Note1. Please refer to standard drawings for cabinet details.

Model	Wall-mounting, indoor/outdoor-use, CA20-45	Name/ Type	CA20-45/LSR			
Body	Steel sheet, t1.2	Drawing number	-			
Door	Steel sheet, t1.2					
Mounting plate	Steel sheet, t1.5	A3 scale	Scale	Design	Drawing	Check
Base	-		1:10	SUPAKIT	SAICHON	TSUGE
Color	Outside Light beige (5Y7/1) (Smooth) Inside Light beige (5Y7/1) (Smooth)	Date	9 / Oct. / 2023 A			
IP	IP65					
Weight	10.3 kg					