

Model	Wall-mounting, indoor/outdoor-use, CA25-44			Name/Type	CA25-44			
Body	Steel sheet, t1.2			Drawing number	-			
Door	Steel sheet, t1.2				1/2			
Mounting plate	Steel sheet, t1.5			A3 scale	Scale	Design	Drawing	Check
Base	-				1:5	SUPAKIT	SUPAKIT	KONISHI
Color	Outside	Light beige (5Y7/1) (Smooth)		Date	21 / Sep. / 2021			
	Inside	Light beige (5Y7/1) (Smooth)						
IP	IP65							
Weight	9.6 kg							

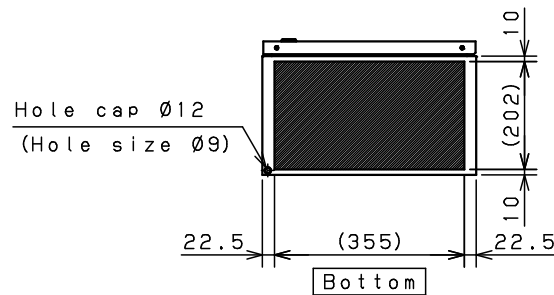
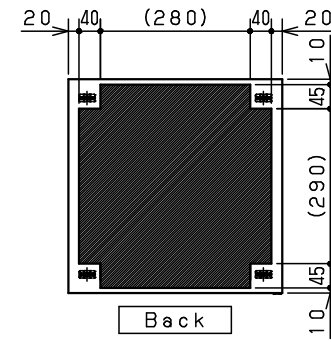
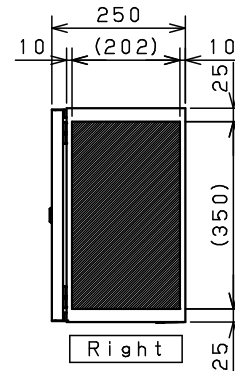
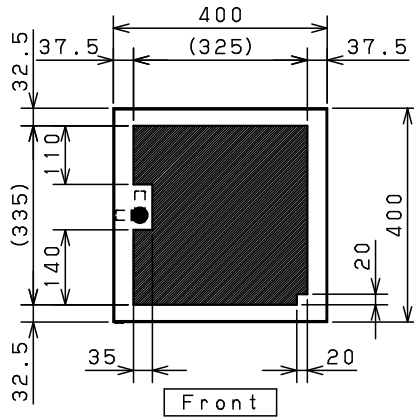
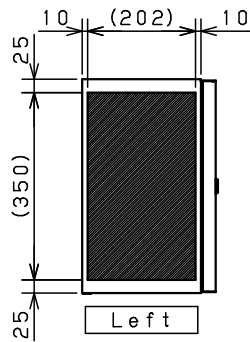
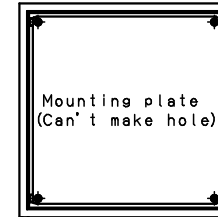
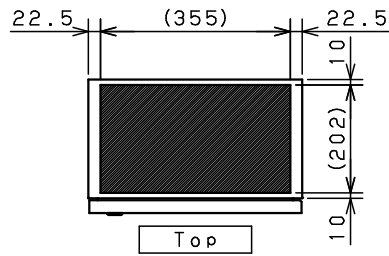

Note2. This drawing shows the processing range by laser.  
 Note1. Please refer to standard drawings for cabinet details.

Model	Wall-mounting, indoor/outdoor-use, CA25-44		Name/Type	CA25-44/LSR			
Body	Steel sheet, t1.2		Drawing number	-			
Door	Steel sheet, t1.2						
Mounting plate	Steel sheet, t1.5		A3 scale	Scale	Design	Drawing	Check
Base	Outside	Light beige (5Y7/1) (Smooth)		1:10	SUPAKIT	SAICHON	TSUGE
Color	Inside	Light beige (5Y7/1) (Smooth)					
IP	IP65		Date	9 / Oct. / 2023 A			
Weight	9.6 kg						