

Model	Wall-mounting, indoor/outdoor-use, CA25-45	Name/Type	CA25-45			
Body	Steel sheet, t1.2	Drawing number	-			
Door	Steel sheet, t1.2		1/2			
Mounting plate	Steel sheet, t1.5					
Base	-	A3 scale	Scale	Design	Drawing	Check
Color	Outside Light beige (5Y7/1) (Smooth) Inside Light beige (5Y7/1) (Smooth)		1:10	SUPAKIT	SUPAKIT	KONISHI
IP	IP65	Date	21 / Sep. / 2021			
Weight	11.2 kg					

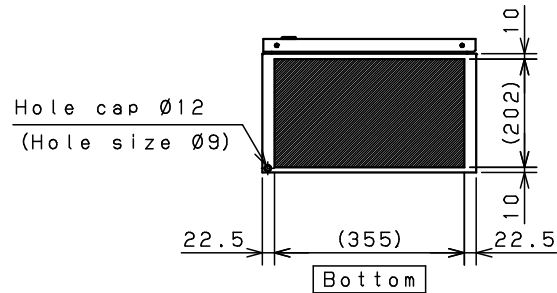
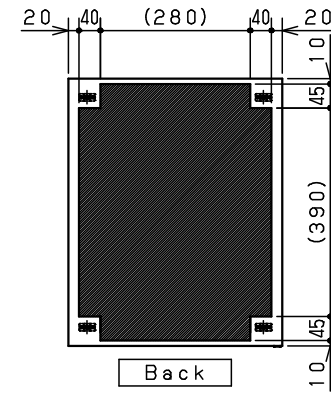
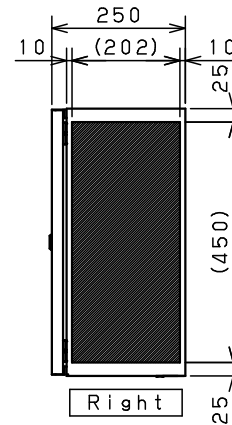
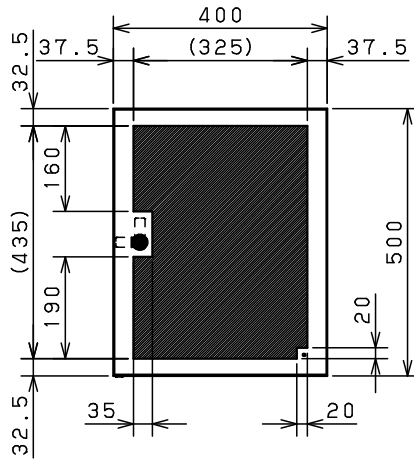
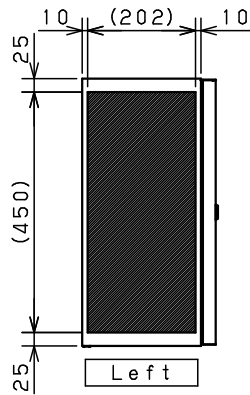
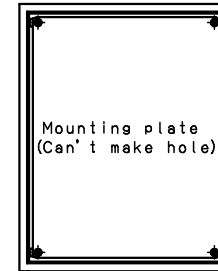
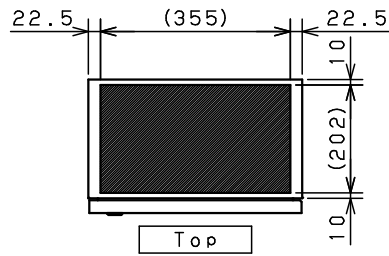

Note2. This drawing shows the processing range by laser.  
 Note1. Please refer to standard drawings for cabinet details.

Model	Wall-mounting, indoor/outdoor-use, CA25-45	Name/ Type	CA25-45/LSR			
Body	Steel sheet, t1.2	Drawing number	-			
Door	Steel sheet, t1.2					
Mounting plate	Steel sheet, t1.5	A3 scale	Scale	Design	Drawing	Check
Base	-		1:10	SUPAKIT	SAICHON	TSUGE
Color	Outside   Light beige (5Y7/1) (Smooth) Inside   Light beige (5Y7/1) (Smooth)	Date	9 / Oct. / 2023 A			
IP	IP65	Weight	11.2 kg			

2/2