

Model	Wall-mounting, indoor/outdoor-use, CAL12-32	Name/Type	CAL 12-32			
Body	Steel sheet, t1.2	Drawing number	-			
Door	Steel sheet, t1.2					
Mounting plate	Steel sheet, t1.5	A3 scale	Scale	Design	Drawing	Check
Base	-		1:4	SUPAKIT	SUPAKIT	KONISHI
Color	Outside Light beige (5Y7/1) (Smooth) Inside Light beige (5Y7/1) (Smooth)	Weight	Date 21 / Sep. / 2021			
IP	IP65					

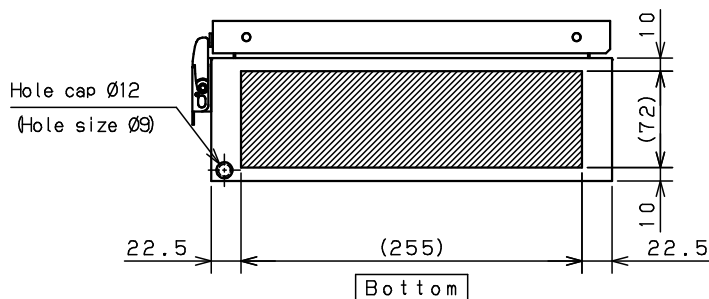
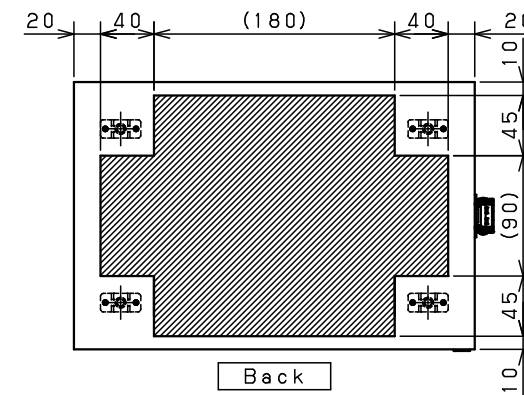
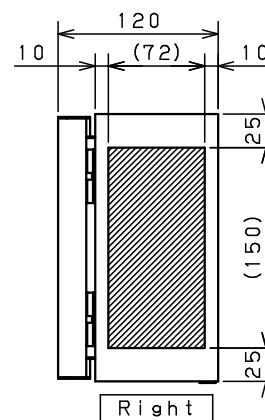
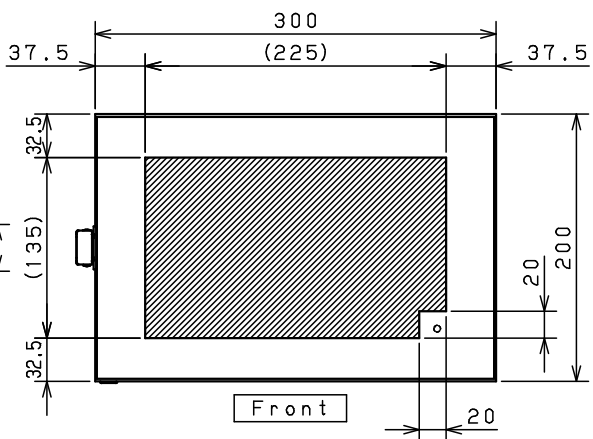
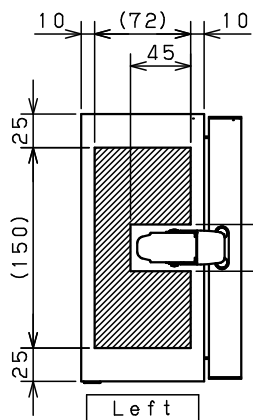
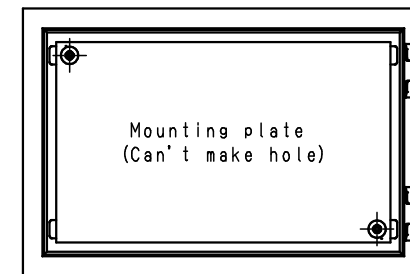
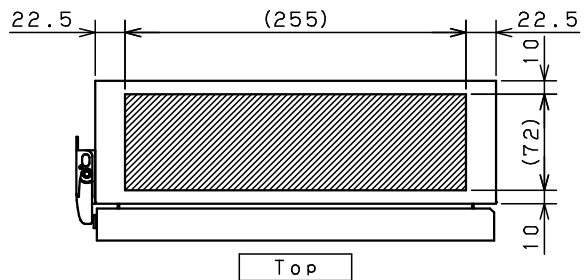

Note2. This drawing shows the processing range by laser.
 Note1. Please refer to standard drawings for cabinet details.

Model	Wall-mounting, indoor/outdoor-use, CAL12-32	Name/ Type	CAL12-32/LSR			
Body	Steel sheet, t1.2	Drawing number	-			
Door	Steel sheet, t1.2					
Mounting plate	Steel sheet, t1.5					
Base	-	A3 scale	Scale	Design	Drawing	Check
Color	Outside Light beige (5Y7/1) (Smooth) Inside Light beige (5Y7/1) (Smooth)		1:4	SUPAKIT	HENGSKU	TSUGE
IP	IP65	Date	9 / Oct / 2023 A			
Weight	3.3 kg					