

Model	Wall-mounting, indoor/outdoor-use, CAL12-33	Name/Type	CAL 12-33			
Body	Steel sheet, t1.2	Drawing number	-			
Door	Steel sheet, t1.2		1/2			
Mounting plate	Steel sheet, t1.5	A3 scale	Scale	Design	Drawing	Check
Base	-		1:4	SUPAKIT	SUPAKIT	KONISHI
Color	Outside Light beige (5Y7/1) (Smooth) Inside Light beige (5Y7/1) (Smooth)	Date	21 / Sep. / 2021			
IP	IP65	Weight	4.6 kg			

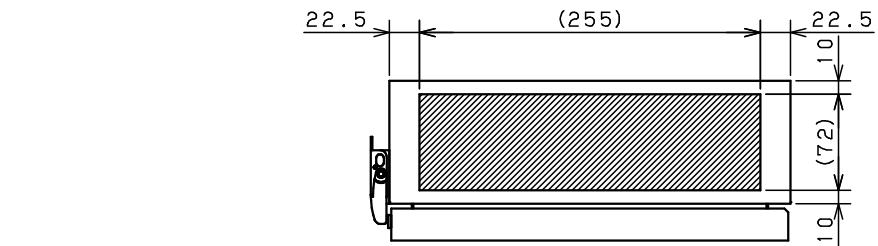

Top

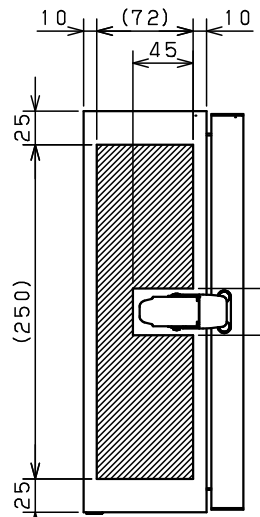
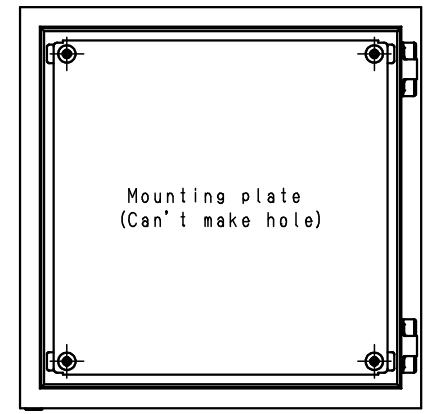

Left

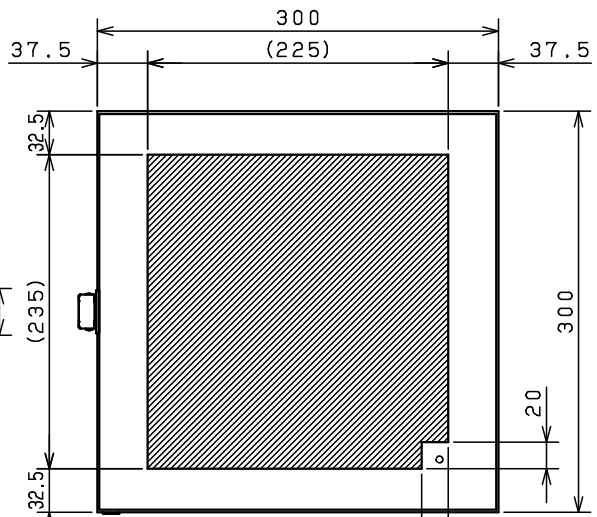

Front

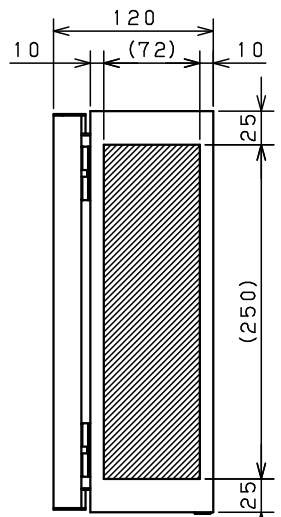

Right

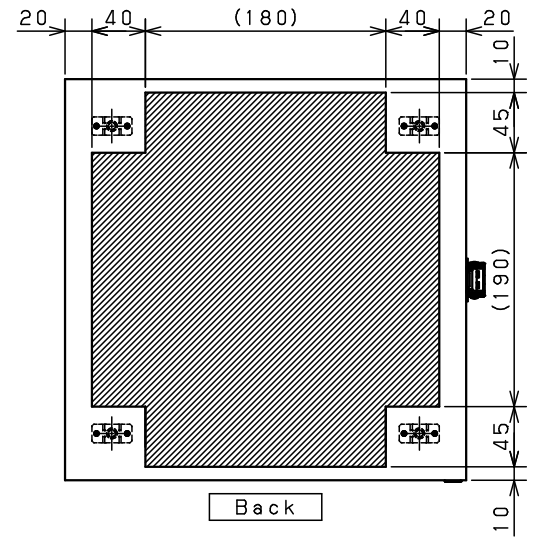

Back

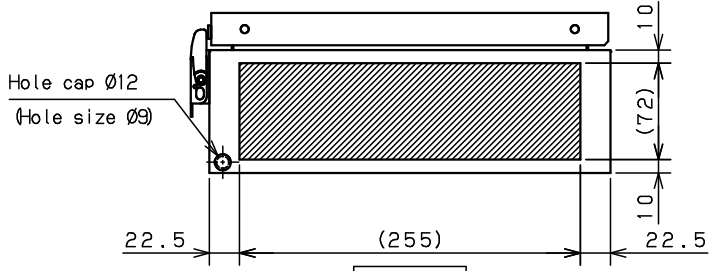

Bottom

Note2. This drawing shows the processing range by laser.
 Note1. Please refer to standard drawings for cabinet details.

Model	Wall-mounting, indoor/outdoor-use, CAL12-33		Name/Type	CAL12-33/LSR			
Body	Steel sheet, t1.2						
Door	Steel sheet, t1.2		Drawing number	-			
Mounting plate	Steel sheet, t1.5						
Base			A3 scale	Scale	Design	Drawing	Check
Color	Outside	Light beige (5Y7/1) (Smooth)		1:4	SUPAKIT	HENGSKUO	TSUGE
IP	IP65		Date	9 / Oct / 2023 A			
Weight	4.6 kg						