

CROSS SECTION A-A
1:2

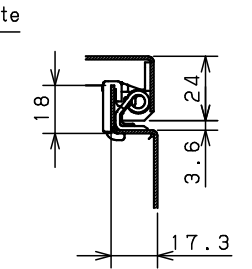

CROSS SECTION B-B
1:2

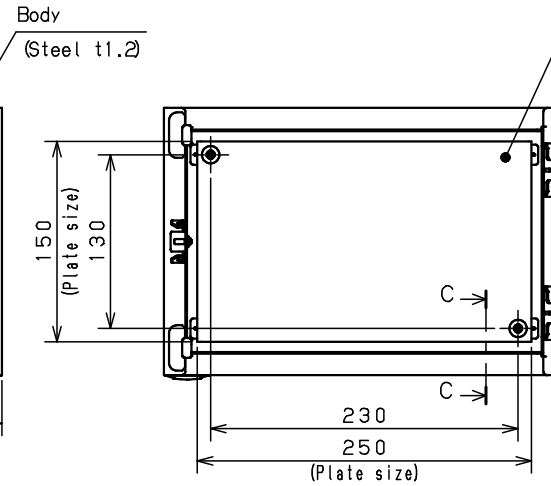
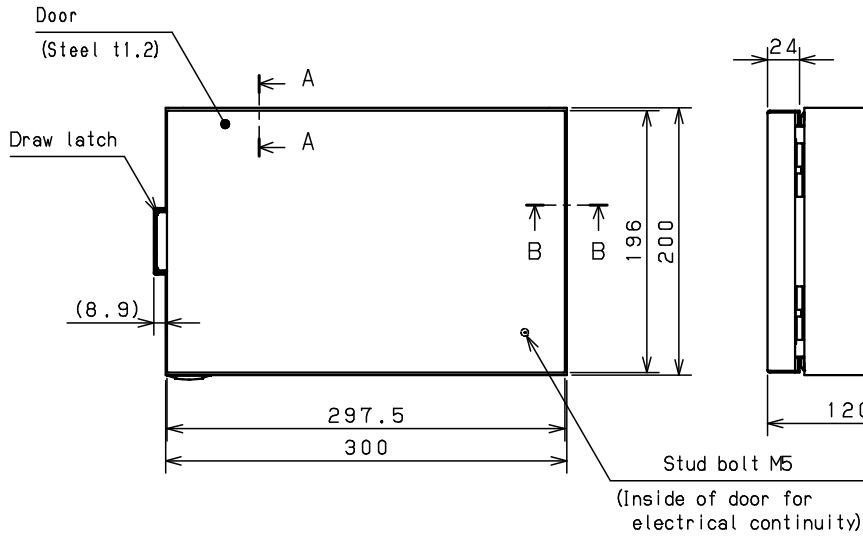
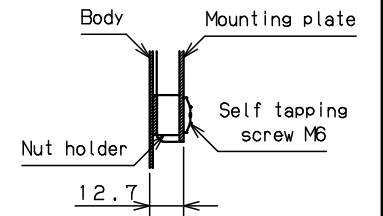

CROSS SECTION C-C
1:2

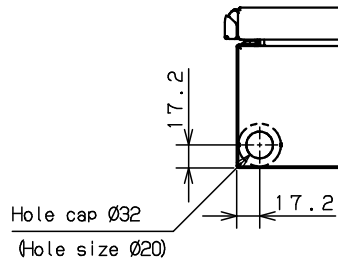

Model	Wall-mounting, indoor-use, CH12-32TH			Name/ Type	CH12-32TH			
Body	Steel sheet, t1.2							
Door	Steel sheet, t1.2							
Mounting plate	Steel sheet, t1.5							
Base	-			Drawing number	-			1/1
Color	Outside	Light beige (5Y7/1) (Smooth)		A3 scale	Scale	Design	Drawing	Check
	Inside	Light beige (5Y7/1) (Smooth)			1:4	SUPAKIT	SUPAKIT	KONISHI
IP	IP4X			Date	13 / Oct. / 2021			
Weight	3.3 Kg							