

CROSS SECTION A-A  
1:2

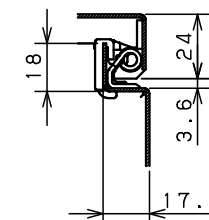

CROSS SECTION B-B  
1:2

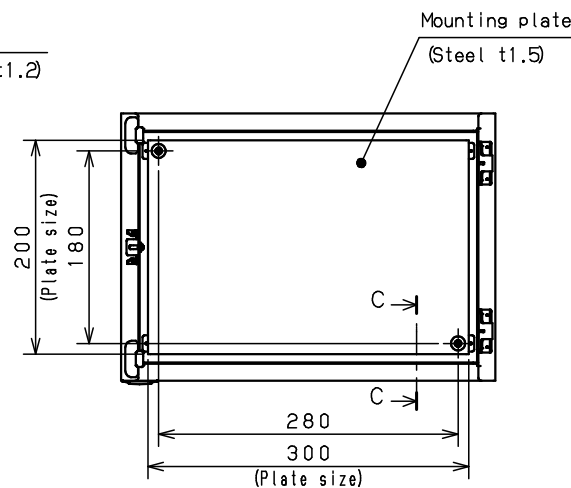
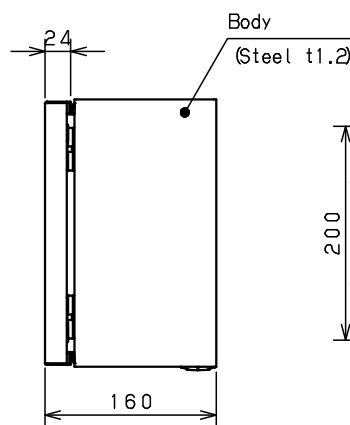
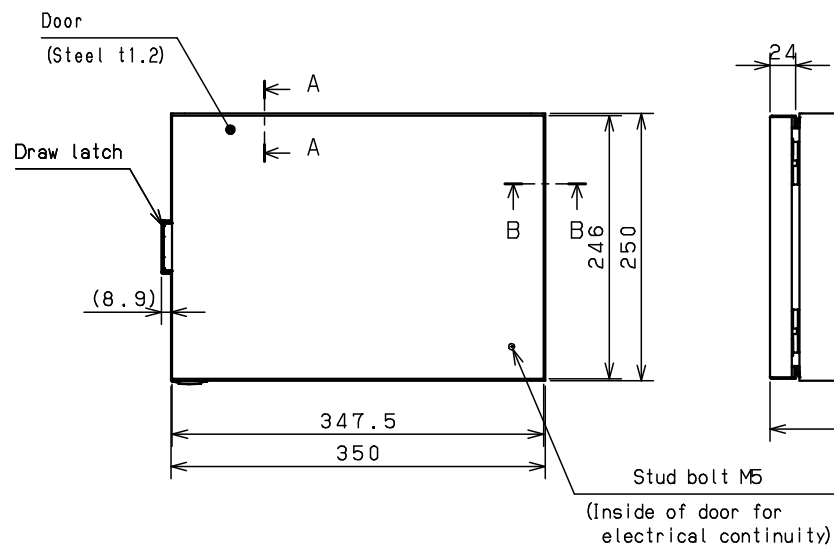
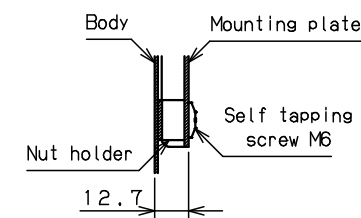

CROSS SECTION C-C  
1:2

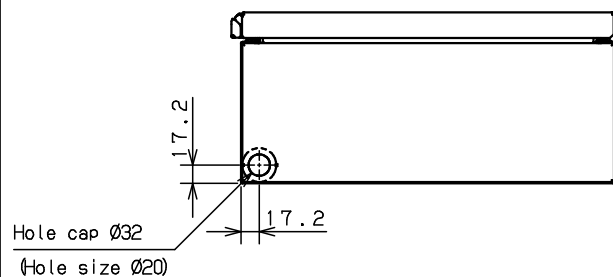

Model	Wall-mounting, indoor-use, CH25-3525TH			Name/Type	CH16-3525TH			
Body	Steel sheet, t1.2				Drawing number	-		
Door	Steel sheet, t1.2			A3 scale		Scale	Design	Drawing
Mounting plate	Steel sheet, t1.5				1:5	SUPAKIT	SUPAKIT	KONISHI
Base	-			Date	13 / Oct. / 2021			
Color	Outside	Light beige (5Y7/1) (Smooth)		Weight	4.9 Kg			
	Inside	Light beige (5Y7/1) (Smooth)						
IP	IP4X							