

CROSS SECTION A-A  
1:2

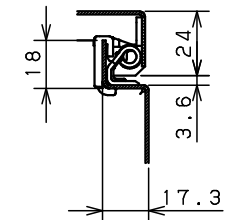

CROSS SECTION B-B  
1:2

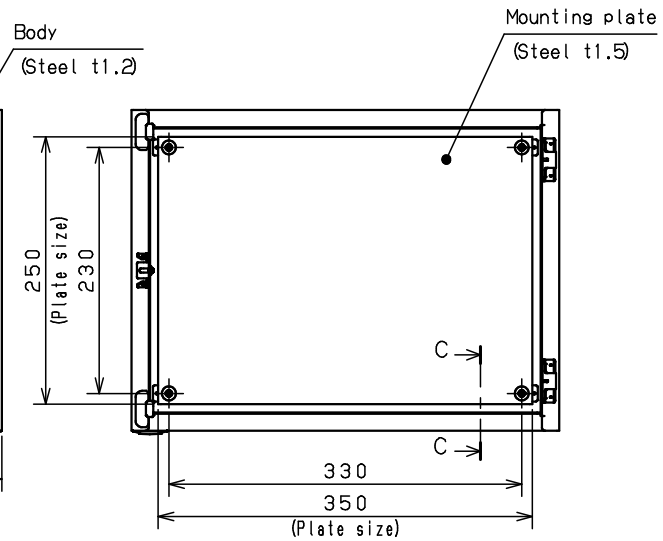
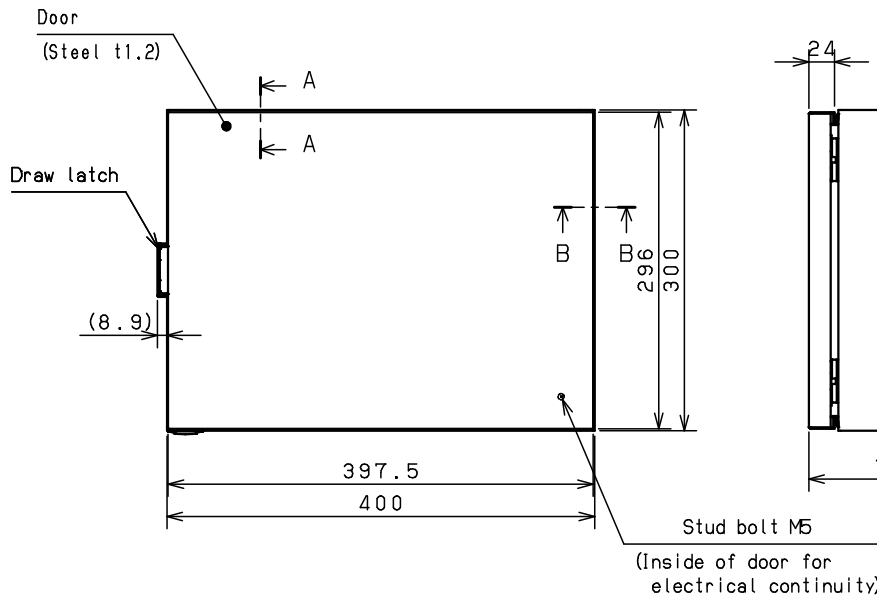
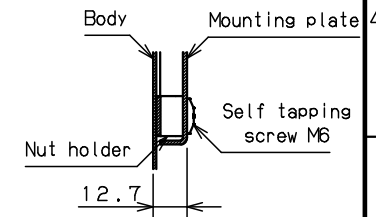

CROSS SECTION C-C  
1:2

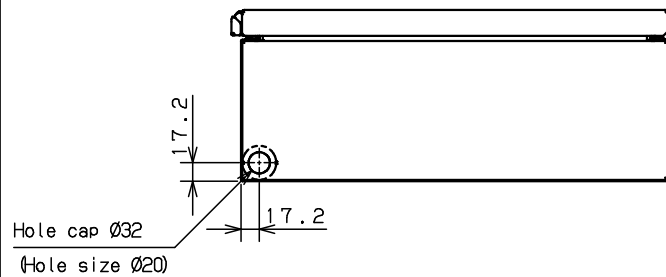

Model	Wall-mounting, indoor-use, CH16-43TH			Name/ Type	CH16-43TH			
Body	Steel sheet, t1.2							
Door	Steel sheet, t1.2							
Mounting plate	Steel sheet, t1.5							
Base	-			Drawing number	- / 1 / 1			
Color	Outside	Light beige (5Y7/1) (Smooth)						
	Inside	Light beige (5Y7/1) (Smooth)		A3 scale	Scale	Design	Drawing	Check
IP	IP4X				1:5	SUPAKIT	SUPAKIT	KONISHI
Weight	6.3 Kg			Date	13 / Oct. / 2021			